

Varenummer: 0106081
 Beskrivelse: Seeger låsering JV 68

Mål

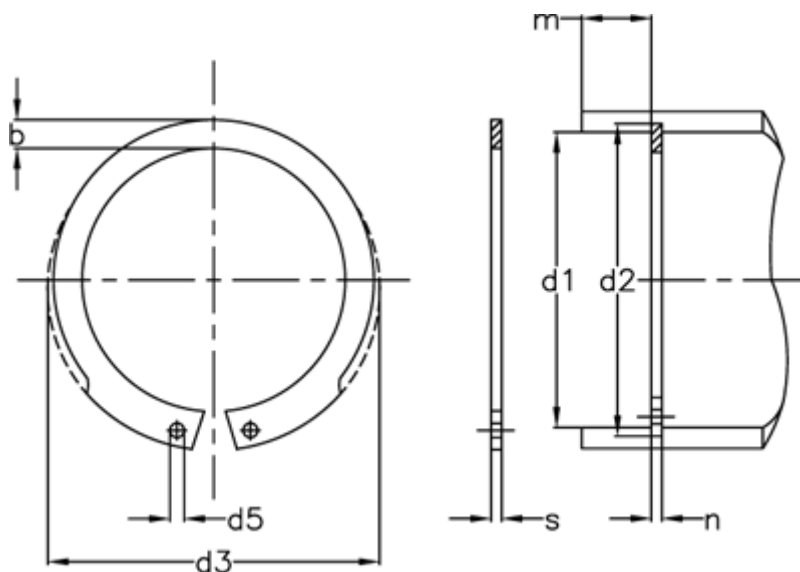

AN mm ²	= 163	FRg kN	= 21.0	Tang	= ZGJ-3
b	= 5.7	FR kN	= 123.0	tol	= -0.07
Betegnelse	= JV 68	g	= 2.5	tol	= +1,10-0,46
d1	= 68	K kN-mm	= 220.0	tol	= +0,30
d2	= 71.0	m min	= 2.65	tol	= 0.3
d3	= 72.5	Nominel træk	= 4.5	vægt kg/1000	= 17.75
d5 min	= 2.5	s	= 2.50		
FN kN	= 27.20	t	= 1.50		